

Philips Professional and Business Solutions

User Manual

26HF7875

26HF5445

32HF7875

32HF5445

42HF7845



PHILIPS

Contents

Contents	1	Installing a System SmartCard or System Box	35
Introduction	2	Diagnosing Basic Problems	37
Kensington Security Slot	2	Appendix A – Multi Remote Controls Support	39
Safety	3	Appendix B – Resolutions Table	40
Troubleshooting	4	Environmental Information	41
Getting started	6	Information for Users in the UK	42
Mounting the TV on a wall.....	6		
Connecting the aerial and mains.....	6		
Putting batteries in the remote control....	6		
Overview of TV Connectors and Controls	7		
Remote Controls	8		
RC2886.....	8		
Guest Remote Control Keys	9		
Overview of TV Setup Main Menu / Sub-Menus	11		
Overview of TV Setup Main Menu / Sub-Menus	12		
Accessing the Setup Menu	13		
Installation	14		
A. Selecting the language.....	14		
B. Selecting your Communication Source	14		
C. Defining the number of available channels	15		
D. Installing the Programmes.....	15		
E. Specifying and Configuring the settings and options	19		
F. Setting up the TV Clock.....	31		
Cloning the TV and the SmartLoader configuration	34		

Introduction

Congratulations on your purchase and welcome to Philips!

This manual contains information about how to install and operate your TV.

 If you still have problems after reading this manual, call your Local Philips Customer or Service Centre. The telephone numbers and addresses are given in the worldwide guarantee booklet supplied with the TV.

Product information

The model and serial number can be found at the rear of the TV, on left side of the TV, and on the packaging

Kensington Security Slot

 (if present)

Your TV is equipped with a Kensington Security Slot, to prevent it from getting stolen. An anti-theft Kensington lock has to be purchased separately. The Kensington lock is a plastic-coated steel cable with a lock. One end has to be fixed to the opening of the TV and locked with a special key. The other end is attached to a fixed point.

® Kensington and MicroSaver are registered US trademarks of ACCO World Corporation with issued registrations and pending applications in other countries throughout the world. All other registered and unregistered trademarks are the property of their respective owners.

Safety

1. Two people are required to lift and carry a TV that weighs more than 25 kilograms. Improper handling of the TV can cause serious injury.
2. If you place the TV set on a solid surface, ensure the surface is level and that it can withstand the weight of the TV.
3. Mounting the TV on the wall requires special skill that should only be performed by a qualified personnel. You should not attempt to do the work yourself. Philips bears no responsibility for improper mounting or mounting that results in accident or injury.
4. This TV is compatible with the VESA wall mounting standard. Please contact your local electronics supplier for a VESA compliant bracket to wall mount this TV. Before you mount your TV on a wall, ensure the wall is suitable to carry the weight of the TV.
5. Wherever you place or mount the TV, ensure that air can circulate freely through the ventilation slots. Do not place the TV in a confined space.
6. Do not place naked flame sources such as lighted candles close to the TV.
7. Do not expose the TV or the batteries of the remote control to heat, direct sunlight, rain, or water.
9. Do not touch any part of the TV, power lead, or aerial lead during lightning storms.
10. Do not leave the TV in stand-by mode for an extended period of time. Instead, disconnect the TV from the mains.
11. The TV set is always connected to the mains. You can disconnect the TV from the mains by doing one of the following tasks:
 - unplugging the mains cord located at the back of TV set
 - unplugging the mains plug from the mains socket outletPull the power cord by the plug - do not pull on the power cord.
12. Ensure that you always have easy access to the mains cord or the mains plug to disconnect the TV from the mains.

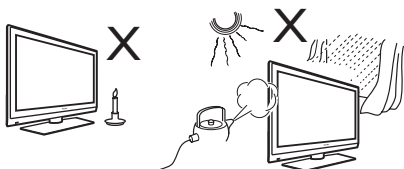

8. Do not place vessels filled with water on top of or near to the TV. Spilling water into the TV can result in electric shock. If you spill water into the TV, do not operate the TV. Immediately disconnect the TV from the mains and have the TV checked by a qualified technician.

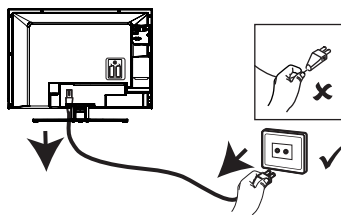

13. Ensure the power cord is fully inserted into the TV mains socket and the wall socket.
14. If the TV is mounted on a swivel base or swivel arm, ensure no strain is placed on the power cord when the TV is swivelled. Strain on the power cord can loosen connections and cause arcing or fire.
15. Verify that the mains supply voltage in your home corresponds to the voltage printed on the sticker at the rear of the TV.

Troubleshooting

If you are experiencing problems, check this list of symptoms and suggested steps to take before requesting service. You may be able to solve the problem yourself.

Note: Please be familiar with the commercial features as described in the TV installation. The effects of several of these features if not thoroughly understood might appear as faulty operation.

Symptoms		Possible Solutions
<i>Installation</i>	TV does not respond to commands of the Setup Remote Control	<ul style="list-style-type: none"> • Check the button on the left hand side of the remote control must be in the SETUP location (see page 13).
	TV does not respond to the Guest Remote Control	<ul style="list-style-type: none"> • Check if YES is selected in the Remote Control Lock feature. Select NO if YES is selected (see page 23)
	Unable to enter Setup menu via Guest Remote Control	<ul style="list-style-type: none"> • Use the Green Remote Control (RC2573) to access Setup menu to reset SECURITY setting (see page 22).
<i>Picture</i>	No picture	<ul style="list-style-type: none"> • Check that the antenna / cable is connected properly at the rear of the TV. • Check picture adjustments (brightness, contrast, colour, tint). • Possible TV station problem. Try another channel. • Ensure VIDEO is not selected in the MUTE feature of the PROGRAM INSTALL menu (see page 18).
	Double image / "ghost" image	<ul style="list-style-type: none"> • Check antenna, cable or set-top box.
	Snowy / noisy picture	<ul style="list-style-type: none"> • Check antenna, cable and /or set-top box connections. Ensure that they are properly connected.
<i>Power</i>	No power	<ul style="list-style-type: none"> • Ensure that the TV's AC power cord is plugged into the main socket and to your TV. If there is still no power, disconnect the plug. Wait for 60 seconds and re-attach plug. Switch on the TV again.
	TV switch off by itself	<ul style="list-style-type: none"> • Check ESP (Energy Saving Programmability) setting in TV installation / setup (see page 24). • Check that POWER SCART in the AUTO SCART feature is not selected (see pages 25 and 26).
	TV cannot be switched off	<ul style="list-style-type: none"> • Ensure FORCED ON is not selected in the POWER ON feature of the SWITCH ON / OSD menu (see pages 20 and 21).

Troubleshooting

Symptoms		Possible Solutions
Power	TV cannot be switched on	<ul style="list-style-type: none"> • If you are using the POWER button of the remote control to switch on the TV, note that button is only use to set the TV to stand-by mode. Use the Digit 0-9 or CH + / – buttons to switch on TV. • Check if YES is selected in the REMOTE CONTROL LOCK feature in SECURITY menu. Select NO to deactivate lock function (see page 23). • Check if ALL is selected in the KEYBOARD LOCK feature in SECURITY menu. Select NO to deactivate lock function (see page 22). Note: If both REMOTE CONTROL LOCK and KEYBOARD LOCK feature are activated, use the Setup Remote Control to go into these two menus to deactivate lock function.
Sound	No Sound	<ul style="list-style-type: none"> • Check if the volume of TV is not at the minimum. Try pressing the Volume Up button of the remote control to increase sound. • Check that the mute mode is not on. If mute mode is on, press the Mute button on the remote control to deactivate mute mode. • Check AUDIO is not selected in the MUTE feature of the PROGRAM INSTALL menu (see page 18). • Check that the audio source in the DEFAULT HDMI AUDIO feature is selected correctly (see page 30).
	Volume level cannot be increased or decreased beyond a certain value	<ul style="list-style-type: none"> • Check the limit setting for the Minimum and Maximum Volume and re-specify the setting in the MIN VOLUME / MAX VOLUME features in the CONTROL menu (see page 27).
Remote Control	TV does not respond to Guest Remote Control	<ul style="list-style-type: none"> • Try changing the batteries. • Aim remote control directly at remote control sensor lens on TV and try pressing any button on the remote control. • Check if YES is selected in the REMOTE CONTROL LOCK feature in SECURITY menu. Select NO to deactivate lock function (see page 23). • Deselect HM - LINK in the COMMUNICATION feature (see page 14).

Note: The Troubleshooting section is applicable only to TV that is installed as a stand-alone. If TV is connected to an interactive system, the behaviour of the TV will be controlled by the system.

Getting started

Mounting the TV on a wall

This TV is compatible with the VESA wall mounting standard. Please contact your local electronics retailer for a VESA compliant bracket to wall mount this TV.

Insert the cables into the TV before you mount it on the wall.

Ensure that there is a distance of at least 30 mm between the wall and the back of the TV. For sets with sub-woofer, an additional 10 mm is required for optimal sound effect.

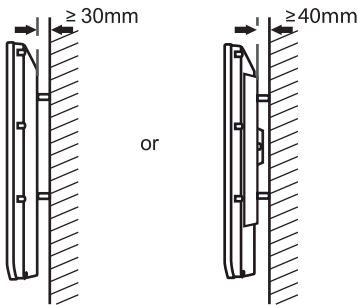

How to switch your TV on

To switch the TV on, press the **POWER** key on the side controls. A green indicator light comes on and after a few seconds the screen lights up.

If the TV set remains in stand-by mode, the indicator light remains red. Press the **PROGRAM +/-** key on the side controls or press the **TV +/-** key on the remote control.

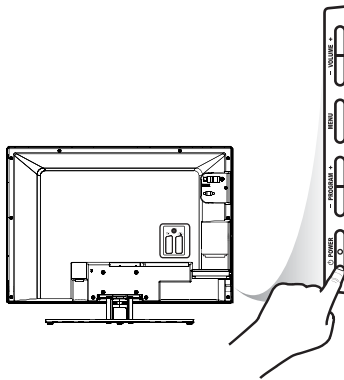

Connecting the aerial and mains

Insert the aerial plug and the mains cord firmly into their respective socket at the bottom of the TV before connecting them into the wall socket.

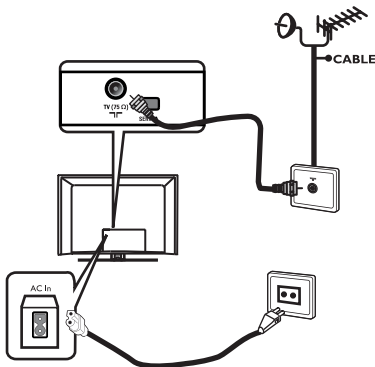

Putting batteries in the remote control

Insert the batteries into the remote control, ensuring that the + and - ends of the batteries are aligned correctly. The correct alignment is indicated inside the casing of the remote control.

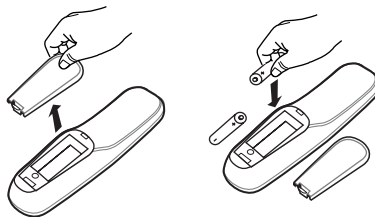

Overview of TV Connectors and Controls

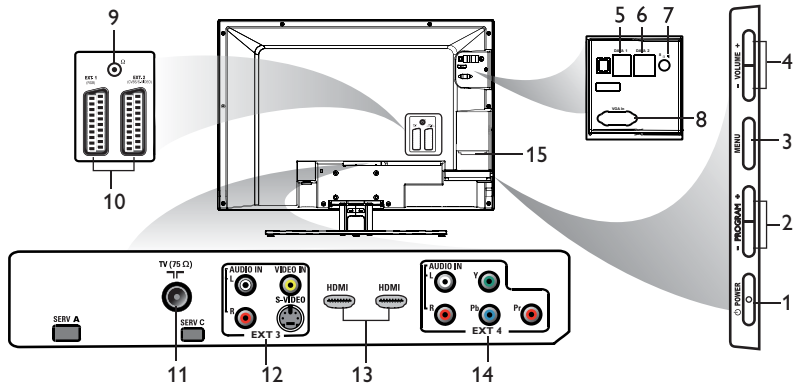

⚠ Warning

Do not connect any telephone cables or equipment to Data 1 (RJ12) & Data 2 (RJ45) connectors.

1. **POWER**
To switch off the TV.
2. **- PROGRAM +**
To switch on TV and also to select the next or previous programme.
3. **MENU**
To display or close menus.
4. **- VOLUME +**
To increase or decrease volume.
5. **Data 1 (RJ 12)**
For System Terminal connection.
6. **Data 2 (RJ 45)**
For SmartCard XpressBox connection.
7. **8 Ω Speaker**
To connect to bathroom speaker. A stereo jack must be used.
8. **VGA In**
For PC/Lap-top VGA input.
9. **Headphones**
To connect headphones. The mute function does not work when headphones are plugged in.
10. **EXT 1 (RGB) and EXT 2 (CVBS/S-VIDEO)**
To connect peripheral equipment.
11. **TV Aerial**
To connect to the aerial plug.
12. **Audio / Video Inputs (EXT 3)**
To connect to video camera or camcorder. Only one video connection can be used at a time.
13. **HDMI 1 / HDMI 2**
To connect to peripheral equipment, including high-definition equipment.
14. **Component Video Inputs/Audio Inputs (EXT 4)**
To connect to DVD or decoder which have the same connectors.
15. **Smart Card Slot**
(Applicable to certain models only).
For use with compatible 32 pin smart card.
Note: For the System SmartCard to function, **NO** must be selected in the **LOW POWER STANDBY** feature of the **FEATURES** menu (see page 28). **YES** must be selected in the **ENABLE CARD SLOT** feature of the **COMMUNICATION** menu.

Remote Controls

The following remote controls are applicable to Philips Professional and Business Solutions TV products. These can be used for setup and configuration purposes.

RC2886

Guest Mode Remote Control



RC2573 is an optional remote control for Institutional TV / Professional and Business Solutions features and SmartCard settings. It can be purchased separately.

Slide this button up to enter into **Guest mode**.

or

Slide this button down to enter into **Setup mode**.



Guest Remote Control Keys

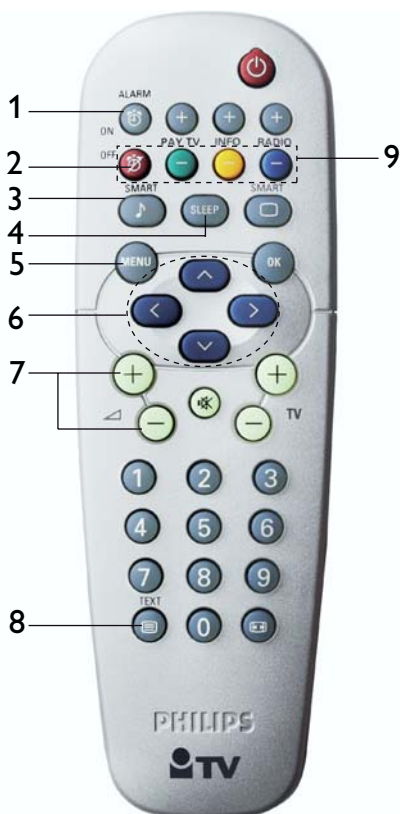

- 1. Alarm On**
To activate the alarm function.
Applicable to models with the clock display.
- 2. Alarm Off**
To deactivate the alarm function.
Applicable to models with the clock display.
- 3. Smart Sound**
To select the predefined sound settings.
- 4. Sleep**
To activate the sleep timer. Press the button repeatedly to increase count-down time.
- 5. Menu**
To call up or exit the menus when a System Box or System SmartCard is installed. For stand alone installation, this function is not applicable.
- 6. Navigation cursors**
To navigate through the menus/sub-menus.
- 7. Volume + / -**
To adjust the TV volume.
- 8. Teletext On / Off**
To switch on / off the teletext function.
- 9. Teletext**
In teletext mode, it allows you to access teletext functions.

Guest Remote Control Keys

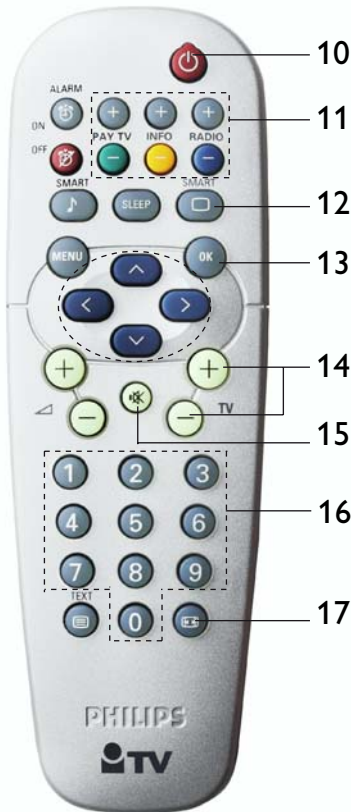

- 10. **Power**
To set the TV to stand-by mode.
- 11. **PAY TV / INFO / RADIO**
To access the first available Pay TV, Info or Radio channel. The + and – buttons allow you to access the next and previous programme.
- 12. **Smart Picture**
To select predefined picture settings.
- 13. **OK**
To confirm a selection.
- 14. **TV + / –**
To switch on TV.
To select the next or previous programme.
- 15. **Mute**
To turn off or on sound.
- 16. **0 to 9 Digit keys**
To switch on TV.
To select a TV channel. For a two digit number, enter the second digit before the dash disappears.
- 17. **Format**
To select TV screen formats.

Overview of TV Setup Main Menu / Sub-Menus

SETUP

LANGUAGE	ENGLISH, FRANCAIS, DEUTSCH, ITALIANO
COMMUNICATION	
COMMUNICATION	SP - SPI, SP - I2C, HM -LINK, SERIAL XPRESS, MULTI RC, SMART RC, OFF
STORE	>
DCM TYPE	GENERIC, NO SOURCE SWITCH
NO. OF PROGRAMS	
TV	35
PAY TV	5
INFO	5
RADIO	5
STORE	>
PROGRAM INSTALL	
PROGRAM NO.	TV 1, INFO 1, PAYTV, RADIO
INPUT	TUNER, AV1, AV2, SVIDEO, EXT3 CVBS, EXT3 SVIDEO, EXT4 CVI. VGA, HDMI1, HDMI 2, *CARD CVBS, *CARD-YC, *CARD EXT4
SYSTEM	WEST EU, UK, EAST EU, FRANCE
FREQUENCY	559.2500 >
LABEL	() >
STORE	>
FINE TUNE	0
MUTE	NONE, AUDIO, VIDEO
TELETEXT LANGUAGE	WEST EU, EAST EU, CYRILLIC, GREEK
PROTECTION	NO, YES

* **CARD CVBS, CARD-YC, CARD EXT4** are available for certain models only.

Overview of TV Setup Main Menu / Sub-Menus

SETUP

CONFIGURATION

- SWITCH ON / OSD _____ >
- PICTURE / SOUND _____ >
- SECURITY _____ >
- CONTROL _____ >
- VIDEO ADJUSTMENT _____ >
- FEATURES _____ >

* CLOCK SETUP

- DISPLAY STANDBY _____ >
- DISPLAY ON _____ >
- TIME SETTING _____ >
- TELETEXT TIME DOWNLOAD _____ >
- DOWNLOAD PROGRAM _____ >
- TIME OFFSET _____ >
- BUZZER VOLUME _____ >

* **CLOCK SETUP** function is available for certain models only.

Accessing the Setup Menu

The following remote control commands are applicable to Philips Professional and Business Solutions products. These can be used for setup and configuration purposes.

Accessing TV Setup Menu using the Remote Control (RC2886)

1. Press the Digit 0-9 buttons to select a channel.



2. Use the Digit 0-9 buttons to press digits 319753 followed immediately by the **M** button. **Note:** Digit buttons **3,1,9,7,5,3** and the **M** button must be pressed successively within 20 seconds for the TV setup menu to be activated.
3. **SECURITY** option in the **CONFIGURATION** menu must be set to **STANDARD** (refer to page 22).

Accessing TV Setup Menu using the Remote Control (RC2573)

1. Slide the button to the **SETUP** location.

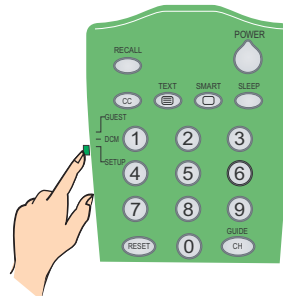

2. Press the **M** button on the remote control to activate the TV Setup Menu.

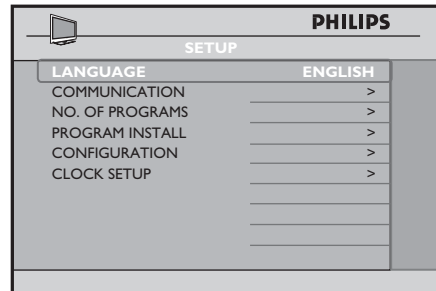

To scroll through the menu :

- Press the **^** or **v** button on the remote control. A highlight indicates that the respective menu item's setting is selected for modification.
- Press the **>** to modify the setting of the selected menu item.
- To exit menu, press the **M** button on the remote control.

Installation

A. Selecting the language

You can select **ENGLISH, FRANCAIS, DEUTSCH** or **ITALIANO** as your preferred language.

- In the **SETUP** menu, press the > button repeatedly to select your preferred language.

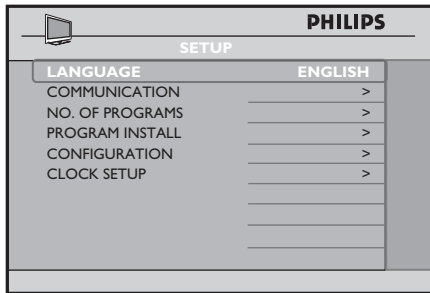

B. Selecting your Communication Source

In the **SETUP** menu, there are seven options in the **COMMUNICATION** menu which can be selected by using the < > buttons on the remote control.

They are **SP - SPI, SP - I2C, HM - LINK, SERIAL XPRESS, MULTI RC, SMART RC** and **OFF**.

The factory default is **OFF**.

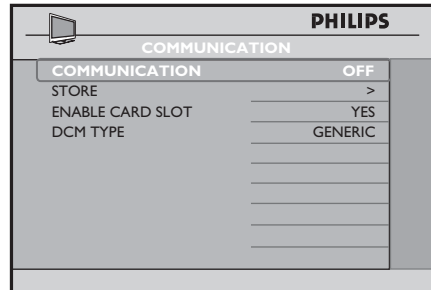
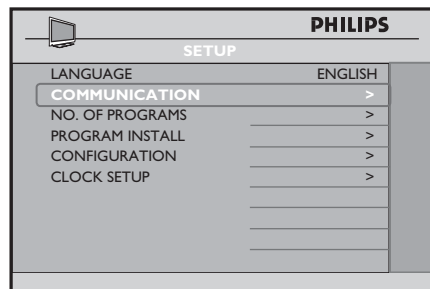

- Press the < or > button to select **SP - SPI, SP - I2C, HM - LINK** or **SERIAL XPRESS** options to allow you to identify a connection link between the TV Display and the setup box.
- Select **YES** in the **ENABLE CARD SLOT** option to enable System Card functions.
- For **SP - SPI** and **SP - I2C**, select **GENERIC** for the **DCM TYPE** item if the set-top box requires source switching. For set-top box that requires no source switching, select **NO SOURCE SWITCH**.
- For **MULTI RC**, select this option to use the specified colour code to correspond to the guest remote control. Refer to Appendix A on page 39 for details on how to configure **MULTI RC** on your guest remote control.
- For **SMART RC**, select this option to enable you to access PAYTV channels via a special remote control. Contact your local PHILIPS sales representative should you require further assistance.
- Proceed to select **STORE** and store all your selections.

Installation

C. Defining the number of available channels

This feature allows you to define the number of available channels for TV, Pay TV, Info (Info Channel) and Radio.

- In the **SETUP** menu, press the ∇ button to highlight **NO. OF PROGRAMS** and press the $>$ button to enter into the **NO. OF PROGRAMS** menu.

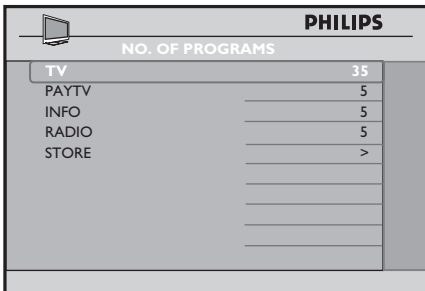
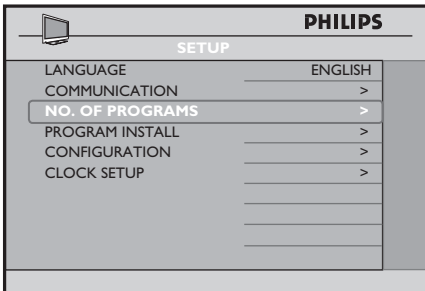

- Press the \wedge or ∇ buttons to select **TV**, **PAYTV**, **INFO** (Info Channel) or **RADIO**.
- Use the **Digit 0 - 9** buttons to define the number of available channels.
- Press the ∇ button repeatedly until **STORE** is highlighted and press the $>$ button to store all the available number of programmes.

Note: The total number of programmes you can define for **TV**, **PAYTV**, **INFO** and **RADIO** is 125. For example, if you define 50 programmes for TV, 30 for PAYTV and 20 for INFO, the number of programmes available for RADIO is 25. The total number of programmes allowed is 125.

D. Installing the Programmes

The **PROGRAM INSTALL** feature allows you to perform the following activities:

1. select a programme number
2. select an input source
3. * select a TV system
4. * tune a channel manually
5. name a channel
6. fine-tune a channel
7. mute the audio or video source
8. * select the teletext language
- lock a channel

* These activities are only available when **TUNER** is selected in the **INPUT** feature.

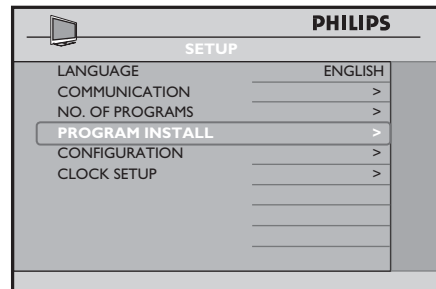

- Press the $>$ button to enter **PROGRAM INSTALL** menu.

Installation

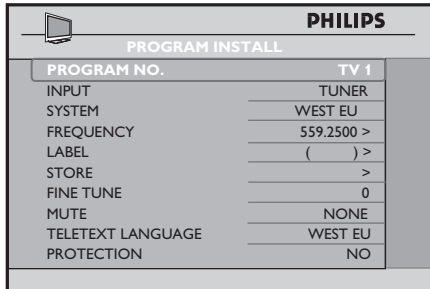

- Press the \wedge or \vee button to select the item you want to configure.
- Press the \lt or \gt button to make adjustment or select option.

1. Selecting a programme number

- Press the \gt button repeatedly to select the desired type of program **TV**, **PAYTV**, **INFO** (Info Channel) or **RADIO**.
- Press the Digit 0 - 9 buttons to select the programme number.

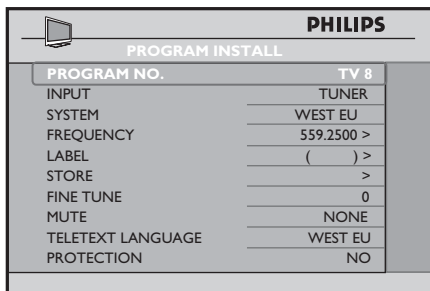

- Press the \vee button repeatedly until **STORE** is highlighted and press the \gt button to store selection.

2. Selecting an input source

- Press the \vee button to select **INPUT**.
- Press the \lt or \gt button repeatedly to select the desired input source (**TUNER**, **AV 1**, **AV 2**, **SVIDEO**, **EXT 3 CVBS**, **EXT 3 SVIDEO**, **EXT 4 CVI**, **VGA**, **HDMI 1**, **HDMI 2**, **CARD-CVBS**, **CARD-YC** or **CARD EXT 4**).

Note : **CARD-YC**, **CARD EXT 4** and **CARD CVBS** are available for certain models only.

If **TUNER** is selected, you can:

- select the TV system
- perform manual installation of channels
- perform fine tuning of channels
- select the teletext language.

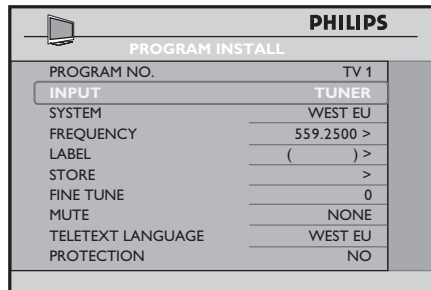

- Press the \vee button repeatedly until **STORE** is highlighted and press the \gt button to store selection.

Installation

3. Selecting the TV system

Note: You can only select **SYSTEM** if **TUNER** is selected in the **INPUT** source.

- Press the ∇ button to select **SYSTEM** and press the $>$ button repeatedly to select the desired system (**WEST EU**, **UK**, **EAST EU** or **FRANCE**).

PHILIPS	
PROGRAM INSTALL	
PROGRAM NO.	TV 1
INPUT	TUNER
SYSTEM	WEST EU
FREQUENCY	559.2500 >
LABEL	() >
STORE	>
FINE TUNE	0
MUTE	NONE
TELETEXT LANGUAGE	WEST EU
PROTECTION	NO

- Press the ∇ button repeatedly until **STORE** is highlighted and press the $>$ button to store selection.

4. Installing the channels manually

Note: You can only tune channels manually if **TUNER** is selected in the **INPUT** feature.

- Press the ∇ button to select **FREQUENCY**.
- Press the $>$ button to start installation of channels or you can use the Digit 0 - 9 buttons to key in the frequency.
- Press the $>$ button to start installation. Once a programme is found, the searching stops.

PHILIPS	
PROGRAM INSTALL	
PROGRAM NO.	TV 1
INPUT	TUNER
SYSTEM	WEST EU
FREQUENCY	559.2500 >
LABEL	() >
STORE	>
FINE TUNE	0
MUTE	NONE
TELETEXT LANGUAGE	WEST EU
PROTECTION	NO

- Press the ∇ button repeatedly until **STORE** is highlighted and press the $>$ button to store selection.

Repeat all the above steps to continue manual installation of channels.

5. Naming a channel

You can assign a label (name) to a channel.

- Press the ∇ button to select **LABEL**.
- Press the $>$ button to move to the first character slot. A red dash will appear.
- Press the \wedge or ∇ button repeatedly to select your desired first character.

PHILIPS	
PROGRAM INSTALL	
PROGRAM NO.	TV 1
INPUT	TUNER
SYSTEM	WEST EU
FREQUENCY	559.2500 >
LABEL	(A) >
STORE	>
FINE TUNE	0
MUTE	NONE
TELETEXT LANGUAGE	WEST EU
PROTECTION	NO

Installation

- Press the > button to move to the next character slot and continue to select the next character with the ^ or v button (maximum of 8 characters).
- Press the **M** button to exit label mode.
- Press the v button to select **STORE**.
- Press the > button to store name.

The name will appear on the top left hand corner of the TV screen when you switch to the channel which have been assigned a name.

6. Fine-tuning the channels

Note: You can only fine tune channels if **TUNER** is selected in the **INPUT** source.

- If the reception is not satisfactory, press the v button to select **FINE TUNE** and adjust using the < or > button.

PHILIPS	
PROGRAM INSTALL	
PROGRAM NO.	TV 1
INPUT	TUNER
SYSTEM	WEST EU
FREQUENCY	559.2500 >
LABEL	(SPORTS) >
STORE	>
FINE TUNE	2
MUTE	NONE
TELETEXT LANGUAGE	WEST EU
PROTECTION	NO

- Press the ^ button to select **STORE**.
- Press the > button to store selection.

7. Muting the Audio or Video source

You can choose to mute the Audio or the Video source.

- Press the v button to select **MUTE**.
- Press the > button repeatedly to select **NONE, AUDIO** or **VIDEO**.
- Press the ^ button repeatedly until **STORE** is highlighted.
- Press the > button to store selection.

PHILIPS	
PROGRAM INSTALL	
PROGRAM NO.	TV 1
INPUT	TUNER
SYSTEM	WEST EU
FREQUENCY	559.2500 >
LABEL	(SPORTS) >
STORE	>
FINE TUNE	2
MUTE	AUDIO
TELETEXT LANGUAGE	WEST EU
PROTECTION	NO

8. Selecting the Teletext language

Note: You can only select the **TELETEXT LANGUAGE** if **TUNER** is selected in the **INPUT** feature.

- Press the v button to select **TELETEXT LANGUAGE**.
- Press the > button repeatedly to select the desired teletext language (**WEST EU, EAST EU, CYRILLIC** or **GREEK**).

Installation

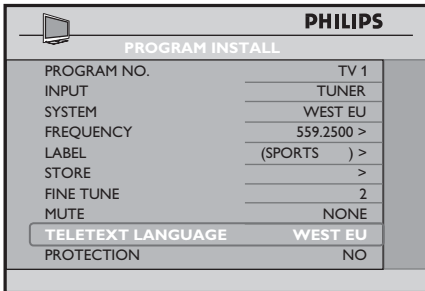

- Press the \wedge button repeatedly until **STORE** is highlighted.
- Press the > button to store selection.

9. Locking the Channels

This feature allows system integrators to lock selected channels to prevent any access to them.

- Press the > button repeatedly to select the desired type of program **TV**, **PAYTV**, **INFO** (Info Channel) or **RADIO**.
- Press the Digit 0 - 9 buttons to select the channel you want to lock.

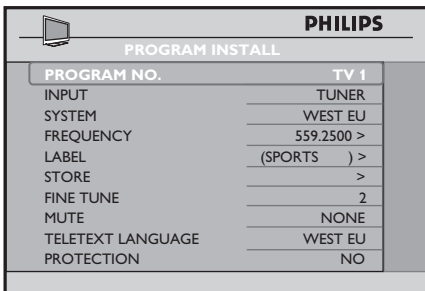

- Press the \vee button repeatedly until **PROTECTION** is highlighted.

- Press the > button to select **YES**.

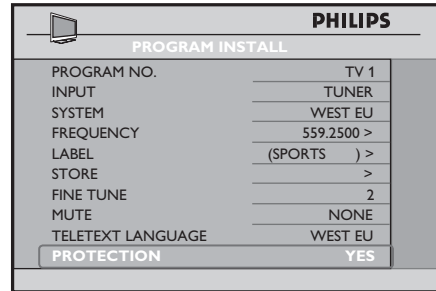

- Press the \wedge button repeatedly until **STORE** is highlighted.
- Press the > button to store selection.

Note: If you access any locked channel, **LOCKED** will appear on the screen.

To unlock channel, do the following:

- select **PROGRAM INSTALL** in the **SETUP** menu.
- select **PROTECTION** in the **PROGRAM INSTALL** menu
- select **NO** in the **PROTECTION** feature.
- select **STORE** and store selection.

E. Specifying and Configuring the settings and options

The **CONFIGURATION** menu allows you to select and configure the settings and options for :

1. SWITCH ON / OSD
2. PICTURE / SOUND
3. SECURITY
4. CONTROL
5. *VIDEO ADJUSTMENT
6. FEATURES

Installation

* **VIDEO ADJUSTMENT** feature is only available when the input source selected is **EXT4 CVI, VGA, HDMI 1** or **HDMI 2**.

- Press the > button to enter **CONFIGURATION** menu.

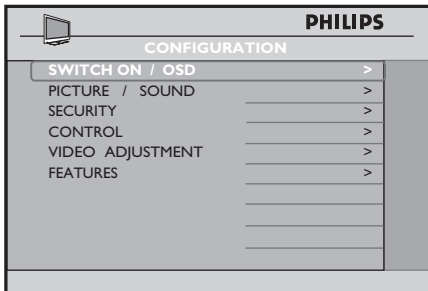

- Press the ^ or v button to select the item you want to configure.
- Press the < or > button to make adjustment or select option.

1. Specifying the configurations when switching on TV

The **SWITCH ON / OSD** menu allows you to select and configure the settings and options for :

- WELCOME MESSAGE
- SWITCH ON PROGRAM
- SWITCH ON VOLUME
- SWITCH ON PICTURE FORMAT
- POWER ON
- VOLUME INDICATOR
- PROGRAM DISPLAY

- Press the > button to enter **SWITCH ON / OSD** menu.

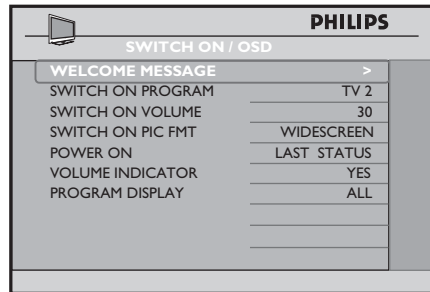

- Press the ^ or v button to select the item you want to configure.
- Press the <, > or Digit 0 -9 buttons to make adjustment or select options.

- **WELCOME MESSAGE:** key in a welcome message.
- **SWITCH ON PROGRAM:** set a channel which you desire the TV to always tune to at startup.
Note: If **STANDARD** is selected in the **SWITCH ON PROGRAM** feature, the TV will switch to the last viewed channel upon start-up.
- **SWITCH ON VOLUME:** specify the volume setting at startup.
- **SWITCH ON PIC FMT:** select your preferred picture format at startup (**AUTO, 4:3, ZOOM 14:9, ZOOM 16:9, SUBTITLE ZOOM, WIDESCREEN, SUPERWIDE** or **FULLSCREEN**).
- **POWER ON:** select the status (**LAST STATUS, ON, STANDBY** or **FORCED ON**) of the TV when switched on.

Installation

If **LAST STATUS** option is selected, the last power status will be activated when TV is switched on.

If **ON** option is selected, the TV will always switch on when the mains cord is inserted in the mains socket and turn on. The **POWER** buttons on the Guest Remote Control and the TV will be enabled.

If **STANDBY** option is selected, the TV will switch on to stand-by mode whenever the main power is switched on.

If **FORCED ON** option is selected, the TV will always switch on when the mains cord is inserted in the mains socket and turn on. The **POWER** buttons on the Guest Remote Control and the TV will be disabled.

- **VOLUME INDICATOR:** display the volume indicator.
- **PROGRAM INDICATOR:** display the programme number, label (if any) or both.

2. Specifying the configurations for PICTURE / SOUND

In the **CONFIGURATION** menu, the **PICTURE / SOUND** feature allows you to select and configure the settings and options for **BRIGHTNESS, COLOUR, CONTRAST, SHARPNESS, TINT, ACTIVE CONTROL, TREBLE, BASS, BALANCE** and **AVL**.

- Press the ∇ button to select **PICTURE / SOUND**.

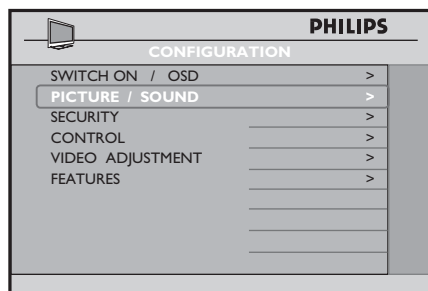

- Press the $>$ button to enter the **PICTURE / SOUND** menu.

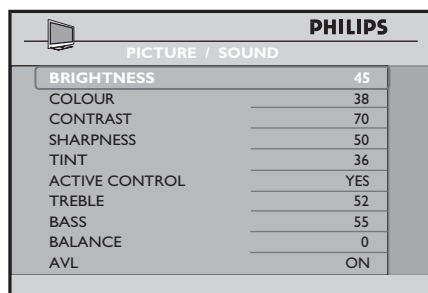

- Press the \wedge or \vee button to select the item you want to configure.
- Press the $<$ or $>$ button to make adjustment or select option.

3. Specifying the Security options

In the **CONFIGURATION** menu, the **SECURITY** feature allows you to select an option to enable access to the **SETUP** menu without a RC2573 setup remote control.

Installation

The **SECURITY** feature allows you to select and configure the settings and options for :

- SECURITY
- KEYBOARD LOCK
- REMOTE CONTROL LOCK
- VIDEO OUT MUTE

- Press the **V** button and select **SECURITY**.

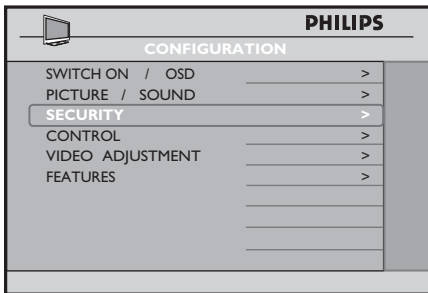

- Press the **>** button to enter the **SECURITY** menu.

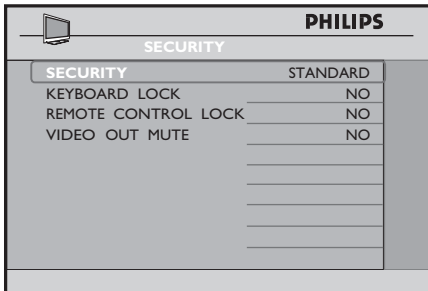

- Press the **^** or **v** button to select the item you want to configure.
- Press the **<** or **>** button to make adjustment or select option.

The **SECURITY** feature offers you two security modes: **STANDARD** and **HIGH**.

- Press the **<** or **>** button to select **STANDARD** or **HIGH**.

If **STANDARD** option is selected, the **TV SETUP** menu can be accessed by entering a special security code with a guest remote control.

Contact your local PHILIPS sales representative should you require further assistance.

If **HIGH** is selected, the TV setup menu can be accessed only with a RC2573 setup remote control in setup mode.

Note: The default security setting is **STANDARD**. When security setting is in **STANDARD** mode, it may be vulnerable to unauthorized operations.

The **KEYBOARD LOCK** feature allows you to lock the TV keyboard buttons.

- Press the **V** button to select **KEYBOARD LOCK**.

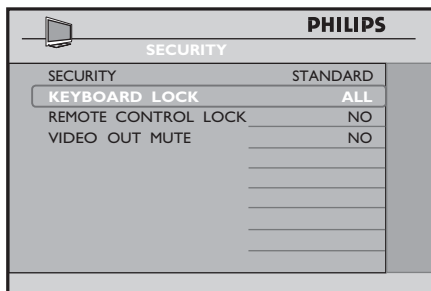

Installation

- Press the > button to select **YES** to lock the TV keyboard buttons except for the POWER button.
- Select **ALL** to lock all the TV keyboard buttons including the POWER button.
- Select **NO** to unlock all the TV keyboard buttons including the POWER button.

The **REMOTE CONTROL LOCK** feature allows you to lock all the guest remote control buttons. This feature is particularly suited for television sets that are used in public areas to prevent guests with a remote from changing the channels, volume, etc.

- Press the V button to select **REMOTE CONTROL LOCK**.

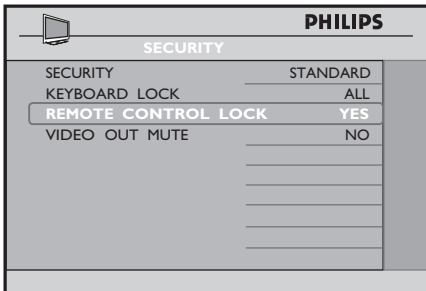

- Press the > button to select **YES** to lock all the guest remote control buttons.

The **VIDEO OUT MUTE** feature allows you to mute the Video from the TV to any external devices.

- Press the V button to select **VIDEO OUT MUTE**.

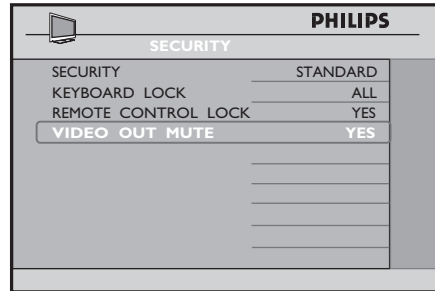

- Press the > button to select **YES** to activate the **VIDEO OUT MUTE** feature.

4. Configuring the Control options

In the **CONFIGURATION** menu, the **CONTROL** feature allows you to select and configure the settings and options for :

- ESP (Energy Saving Programmability)
- AUDIO / VIDEO MUTE
- STEP TUNING
- DIGIT TIMEOUT
- AUTO SCART
- ALWAYS RGB
- MINIMUM VOLUME
- MAXIMUM VOLUME

- Press the V button to select **CONTROL**.

Installation

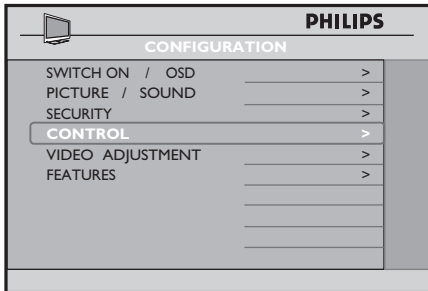

- Press the > button to enter the **CONTROL** menu.

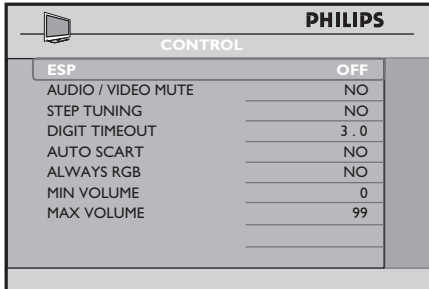

- Press the ^ or v button to select the item you want to configure.
- Press the < or > button to make adjustments or select option.

The **ESP** (Energy Saving Programmability) function allows you to select a specified period of time (from 1 HR / 2 HR / 99 HR) to power down your TV automatically. If it does not receive any commands during this period from the remote control or the TV keyboard, this energy saving feature will take effect.

Note : If a remote or keyboard command is received before the ESP time period expires, the Timer will reset and begin counting down again.

- Press the < or > button to select a specified time period.

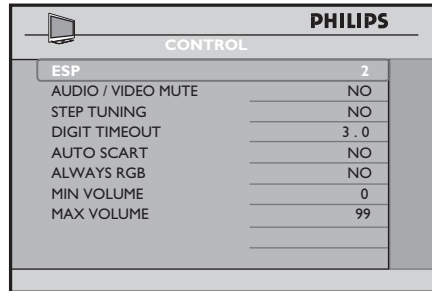

The **AUDIO / VIDEO MUTE** feature allows you to mute the **AUDIO** and **VIDEO** source if any loss of signal transmission occurs.

- Press the v button to select **AUDIO / VIDEO MUTE**.

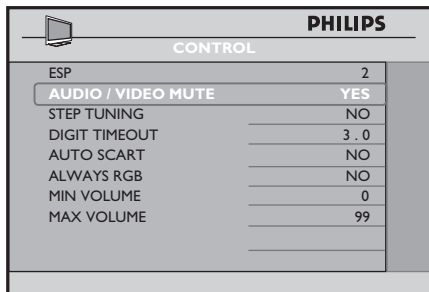

- Press the > button to select **YES** to mute **AUDIO** and **VIDEO** source.

Installation

The **STEP TUNING** feature allows tuning to be performed for each digit entry if **YES** is selected.

- Press the **V** button to select **STEP TUNING**.

PHILIPS	
CONTROL	
ESP	2
AUDIO / VIDEO MUTE	YES
STEP TUNING	YES
DIGIT TIMEOUT	3.0
AUTO SCART	NO
ALWAYS RGB	NO
MIN VOLUME	0
MAX VOLUME	99

- Press the **>** button to select **YES** to activate **STEP TUNING** function.

The **DIGIT TIMEOUT** feature allows you to specify a time period (from 1 second to 9.9 seconds) for the channel to switch to another channel when you key in the channel number. It is advisable not to specify too short a time period especially when you want to key in a 2- digit channel number. For example, if you specify a 1 second time period, you may not have enough time to key the second digit as the channel will switch after you key in the first digit.

Note : The recommended and default setting is 3.0 seconds.

- Press the **V** button to select **DIGIT TIMEOUT**.

PHILIPS	
CONTROL	
ESP	2
AUDIO / VIDEO MUTE	YES
STEP TUNING	YES
DIGIT TIMEOUT	3.0
AUTO SCART	NO
ALWAYS RGB	NO
MIN VOLUME	0
MAX VOLUME	99

- Press the **<** or **>** button to specify a time period.

In the **AUTO SCART** feature, the TV will automatically switch to the designated source where scart signal at the designated source is detected.

- Press the **V** button to select **AUTO SCART**.
- Press the **<** or **>** button to select **NO**, **AV1 (EXT 1)**, **AV2 (EXT 2)**, **ALL** or **POWER SCART**.

PHILIPS	
CONTROL	
ESP	2
AUDIO / VIDEO MUTE	YES
STEP TUNING	YES
DIGIT TIMEOUT	3.0
AUTO SCART	AV1
ALWAYS RGB	NO
MIN VOLUME	0
MAX VOLUME	99

If **AV 1 (EXT 1)** is selected and you are watching TV from the RF source, the TV switches automatically to the AV1 channel when a scart cable is connected to a AV1 connector.

Installation

If **ALL** is selected, the TV will then react to both AV1 and AV2.

If **POWER SCART** is selected, the TV when in stand-by mode will automatically switch on when a scart signal is detected. Likewise, when a scart signal is not detected, the TV will go to stand-by automatically.

PHILIPS	
CONTROL	
ESP	2
AUDIO / VIDEO MUTE	YES
STEP TUNING	YES
DIGIT TIMEOUT	3 . 0
AUTO SCART	POWER SCART
ALWAYS RGB	NO
MIN VOLUME	0
MAX VOLUME	99

The **ALWAYS RGB** feature controls RGB insertion in TV auxiliary sources.

- Press the ∇ button to select **ALWAYS RGB**.
- Press the $<$ or $>$ button to select **NO**, **AUTO** or **AV1 (EXT 1)**.
- Select **NO** to allow RGB insertion in AV1 (EXT 1) only.

PHILIPS	
CONTROL	
ESP	2
AUDIO / VIDEO MUTE	YES
STEP TUNING	YES
DIGIT TIMEOUT	3 . 0
AUTO SCART	POWER SCART
ALWAYS RGB	NO
MIN VOLUME	0
MAX VOLUME	99

- Select **AV1 (EXT 1)** to allow RGB insertion in AV1 (EXT 1) and other sources.

PHILIPS	
CONTROL	
ESP	2
AUDIO / VIDEO MUTE	YES
STEP TUNING	YES
DIGIT TIMEOUT	3 . 0
AUTO SCART	POWER SCART
ALWAYS RGB	AV1
MIN VOLUME	0
MAX VOLUME	99

- If **COMMUNICATION** is **SP-SPI** or **SP-I2C**, select **AUTO** to allow RGB insertion in AV1 (EXT 1) and other sources.

PHILIPS	
COMMUNICATION	
COMMUNICATION	SP - SPI
STORE	>
ENABLE CARD SLOT	YES
DCM TYPE	GENERIC

PHILIPS	
CONTROL	
ESP	2
AUDIO / VIDEO MUTE	YES
STEP TUNING	YES
DIGIT TIMEOUT	3 . 0
AUTO SCART	POWER SCART
ALWAYS RGB	AUTO
MIN VOLUME	0
MAX VOLUME	99

Installation

- If **COMMUNICATION** is not **SP-SPI** or **SP-I2C**, select **AUTO** to allow RGB insertion in AV1 (EXT1) and not other sources.

The **MIN** and **MAX VOLUME** options allow you to specify the limit setting for Minimum and Maximum Volume.

- Press the **V** button repeatedly to select **MIN VOLUME** or **MAX VOLUME**.
- Press the **<** or **>** button to specify a minimum or maximum volume setting.

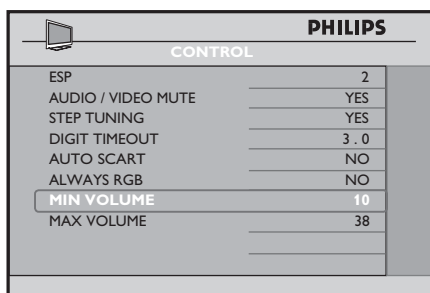

5. Adjusting the Picture

In the **CONFIGURATION** menu, the **VIDEO ADJUSTMENT** feature allows you to :

- adjust the picture horizontally and vertically.
- *eliminate horizontal and vertical interfering lines.
- *adjust the positioning of the picture automatically.
- *return to the factory settings (default settings).

- * Functions available only when the input sources selected are **VGA**, **EXT4 CVI** and **CARD EXT4**.

Note: VIDEO ADJUSTMENT

feature is only available when the input source is in **EXT4 CVI**, **VGA**, **HDMI 1** or **HDMI 2**.

- Press the **V** button repeatedly until **VIDEO ADJUSTMENT** is highlighted.

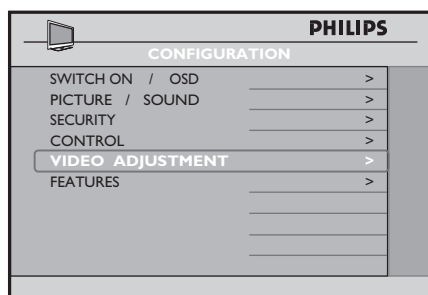

- Press the **>** button to enter **VIDEO ADJUSTMENT** menu.

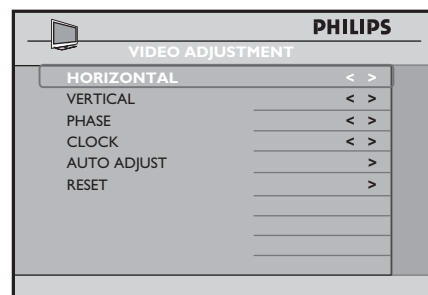

The **HORIZONTAL** and **VERTICAL** options allow you to adjust the picture horizontally and vertically. This is useful for configuring channels that have tickers or scrolling banners at the bottom such as news and sports channels.

Installation

Note: **HORIZONTAL** and **VERTICAL** options are only available when the input sources selected are **HDMI 1** or **HDMI 2**.

- Press the \wedge or \vee button to select **HORIZONTAL** or **VERTICAL**.

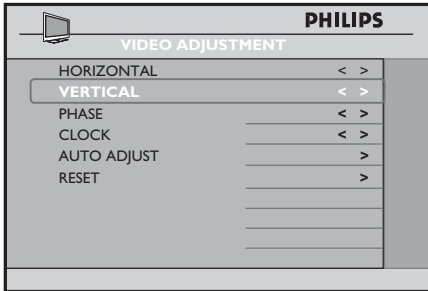

- Press the $<$ or $>$ button to adjust the picture horizontally or vertically.

The **PHASE** and **CLOCK** options allow you to eliminate the horizontal and vertical interfering lines.

Note: **CLOCK** refers to the video properties of the VGA signal.

- Press the \vee button to select **PHASE** or **CLOCK**.

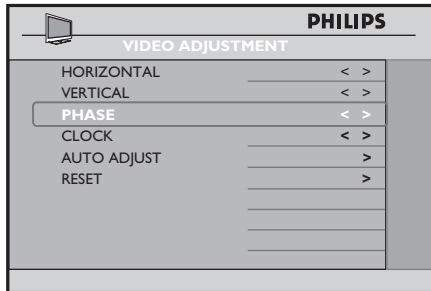

- Press the $<$ or $>$ button to select **PHASE** or **CLOCK** to eliminate the horizontal or vertical interfering lines.

Note: **PHASE** and **CLOCK** options are only available when the input sources selected are **VGA**, **EXT4 CVI** and **CARD EXT4**.

The **AUTO ADJUST** option allows you to adjust the positioning of the picture automatically. **Note:** **AUTO ADJUST** is only available when the input sources selected are **VGA**, **EXT4 CVI** and **CARD EXT4**.

- Press the \vee button to select **AUTO ADJUST**.

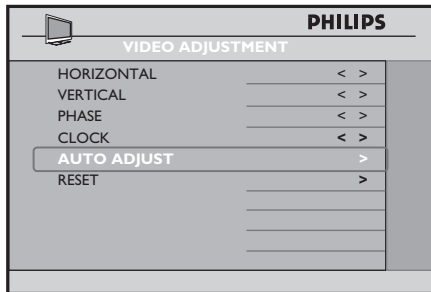

- Press the $>$ button to activate option.

Installation

The **RESET** option allows you to return to the factory settings (default settings).

Note: **RESET** is only available when the input sources selected are **VGA**, **EXT4 CVI** and **CARD EXT4**.

- Press the **V** button to select **RESET**.

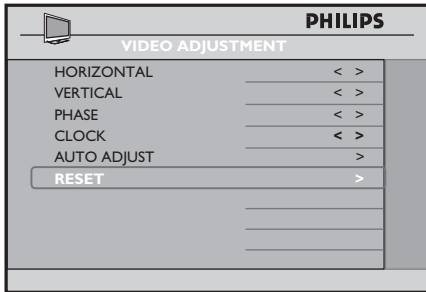

- Press the **>** button to return to the factory settings (default settings).

6. Configuring the Features options and settings

In the **CONFIGURATION** menu, **FEATURES** allows you to select and configure the settings and options for:

- SMART POWER
- SMART SOUND KEY
- DEFAULT HDMI 1 AUDIO
- DEFAULT HDMI 2 AUDIO
- LOW POWER STANDBY

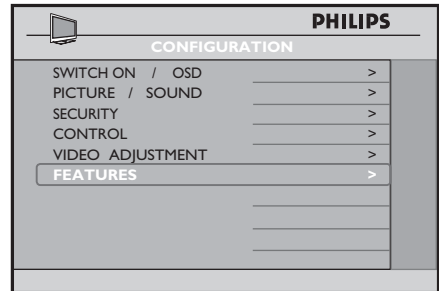

- Press the **>** button to enter the **FEATURES** menu.

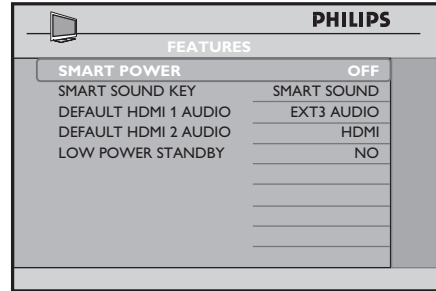

- Press the **^** or **v** button to select the item you want to configure.
- Press the **<** or **>** button to select the options.

The **SMART POWER** feature allows you to put the TV in an energy saving mode which can reduce energy consumption.

- Press the **<** **>** buttons to select **LOW**, **MEDIUM** or **HIGH** to activate energy saving mode. To de-activate energy saving mode, select **OFF**.

Installation

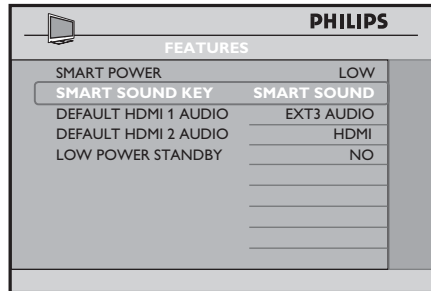
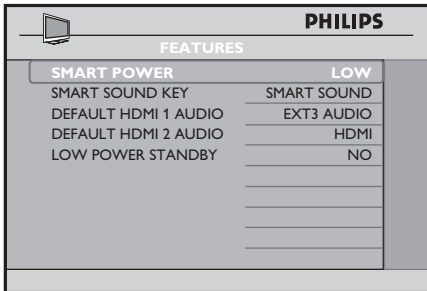

The **SMART SOUND KEY** option allows you to select between **AUDIO SELECT** or **SMART SOUND**.

- Press the ∇ button to select **SMART SOUND KEY**.

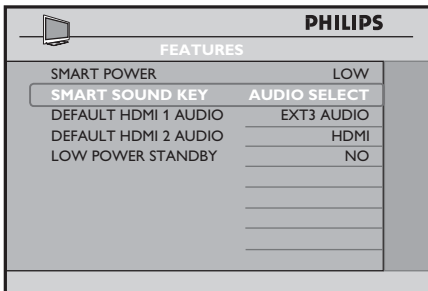

The **DEFAULT HDMI 1 AUDIO** or **DEFAULT HDMI 2 AUDIO** option allows you to define the HDMI Audio from different Sources. This feature is particularly useful for connecting DVI sources to this television. DVI Video can convert easily to HDMI with a simple adaptor, but the audio signal is not present and must then be connected to one of the other inputs on the TV. This feature allows you to match the DVI video to the Audio signal you have connected.

- Press the ∇ button to select **DEFAULT HDMI 1 AUDIO** or **DEFAULT HDMI 2 AUDIO**.

- Press the $<$ or $>$ button to select **AUDIO SELECT** or **SMART SOUND**.

Select **AUDIO SELECT** to allow you to configure the Smart Sound button on the Guest remote control to toggle the different audio sources.

Select **SMART SOUND** to allow you to configure the Smart Sound button on the Guest remote control to listen to different **SMART SOUND** modes.

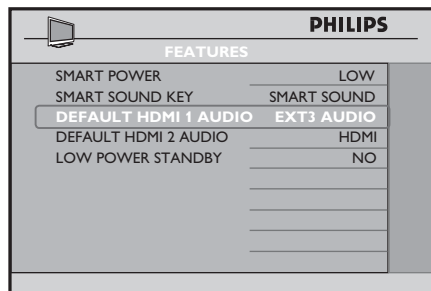

- Press the $<$ or $>$ button to select **EXT3 AUDIO**, **EXT4 AUDIO** or **HDMI**.

Installation

The **LOW POWER STANDBY** option allows you to save electricity when TV is in stand-by mode.

- Press the ∇ button repeatedly until **LOW POWER STANDBY** is highlighted.

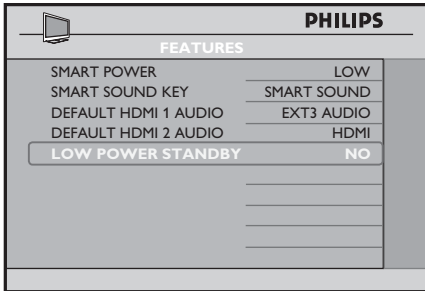

- Press the \triangleright button to select **YES** to activate **LOWER POWER STANDBY** option.

Note: By default, **LOW POWER STANDBY** is set to **NO**.

LOW POWER STANDBY must be set to **NO** if connected to a System Box or System SmartCard.

F. Setting up the TV Clock

For some models, the TV has a clock displayed at the front bottom of the TV.

In the **SETUP** menu, the **CLOCK SETUP** feature allows you to select and configure the settings and options for :

1. DISPLAY STANDBY
2. DISPLAY ON
3. TIME SETTING
4. TELETEXT TIME DOWNLOAD
5. DOWNLOAD PROGRAM
6. TIME OFFSET

7. BUZZER VOLUME

Note : **CLOCK SETUP** feature is applicable for certain models only.

- Press the \wedge or ∇ button repeatedly until **CLOCK SETUP** is highlighted.

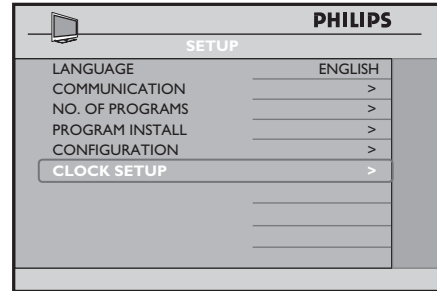

- Press the \triangleright button to enter **CLOCK SETUP** menu.

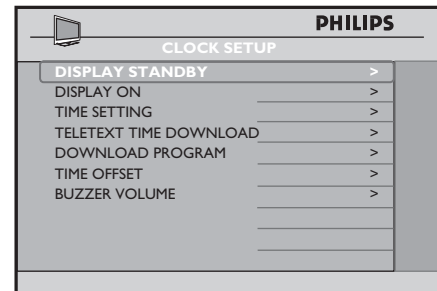

- Press the \wedge or ∇ button to select the item you want to configure.
- Press the \triangleleft or \triangleright button to select the option or make adjustment.

1. Setting the brightness level of the clock when the TV is on Standby

In the **CLOCK SETUP** menu, the **DISPLAY STANDBY** allows you to set the brightness level of the clock display when the TV is in stand-by mode.

Installation

- Press the < or > button to set the brightness level (1 - 5 and OFF).

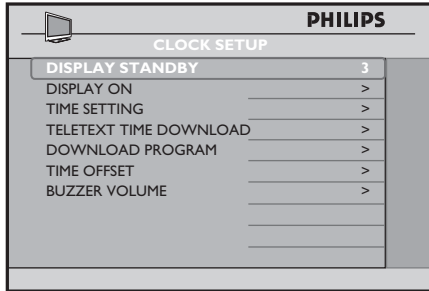

2. Setting the brightness level of the clock when the TV is switched on

You can also set the brightness level of the clock display when the TV is switched on.

- Press the √ button to select **DISPLAY ON**.

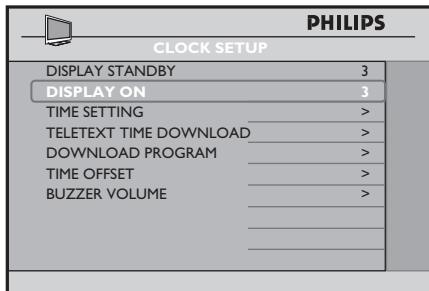

- Press the < or > button to set the brightness level (1 - 5 and OFF).

3. Setting the time of the Clock manually

You can set the time of the clock manually by keying in the time in the **TIME SETTING** option.

- Press the ^ or v button to select **TIME SETTING**.

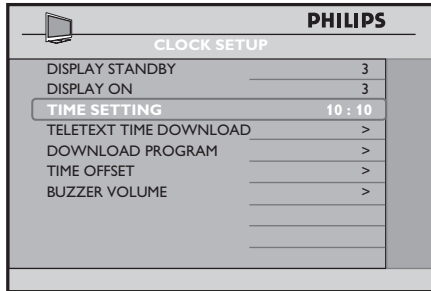

- Press the <, > or the Digit 0 - 9 buttons to key in the time.

4. Setting the time of the Clock via Teletext Time Download

You can also set the time of the clock to activate or deactivate the function for automatic time downloading via Teletext. The TV clock will be automatically synchronised to the correct time.

- Press the ^ or v button to select **TELETEXT TIME DOWNLOAD**.

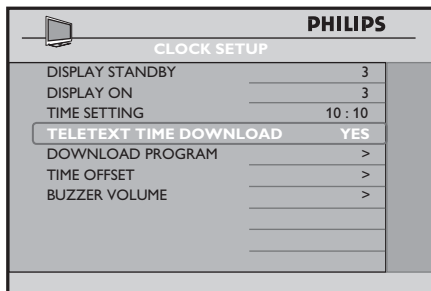

- Press the < or > button to select **YES** to download time automatically via teletext.

Installation

5. Retrieving the correct time from Teletext of the selected channel

You can select a channel which has teletext transmission from which the correct time from the teletext is retrieved.

- Press the \wedge or \vee button to select **DOWNLOAD PROGRAM**.

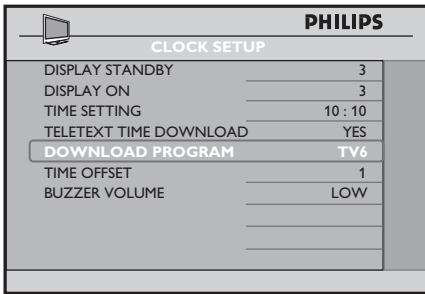

- Press the $<$ or $>$ button to select **TV1, INFO 1, PAY TV, AV1 (EXT 1), SVIDEO or AV2 (EXT 2)**.
- Use the Digit 0 - 9 buttons to select the teletext channel for **TV1, INFO 1, PAY TV, AV1 (EXT 1), SVIDEO or AV2 (EXT 2)**.

For example, if you select Channel 6 in TV1 option, the time of the selected teletext channel will be retrieved.

6. Offsetting the clock time

The **TIME OFFSET** option allows you to set the offset time needed to adjust the time received from the teletext channel to represent the current time in the current location.

- Press the \wedge or \vee button to select **TIME OFFSET**.

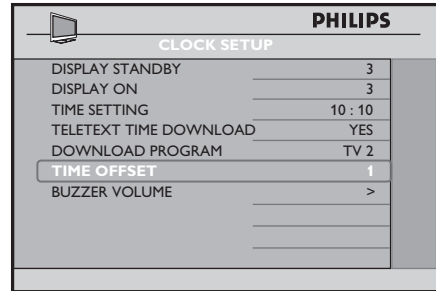

- Press the $<$ or $>$ button to select the time difference (1 to 12 hours).

7. Setting the Buzzer Volume

The **BUZZER VOLUME** option allows you to set the volume of the alarm buzzer.

- Press the \wedge or \vee button to select **BUZZER VOLUME**.

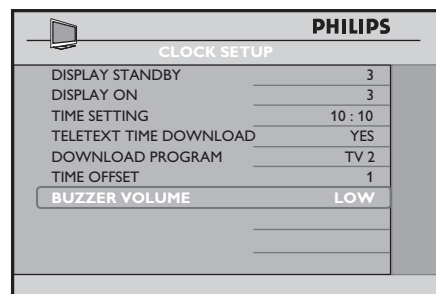

- Press the $<$ or $>$ button to select **OFF, LOW, or HIGH**.

Cloning the TV and the SmartLoader configuration

Cloning the TV configuration to the SmartLoader

- Slide button on the left of the SmartLoader up to the  position. Aim SmartLoader at green LED of the TV (5 to 15 cm away).

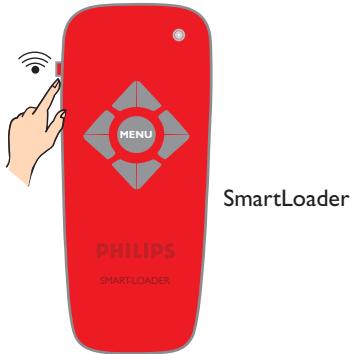

- Press the **MENU** button on the SmartLoader to display the menu on TV.

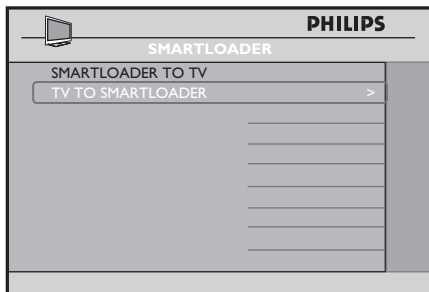

- Press the **∨** button to select **TV TO SMARTLOADER**.
- Press the **>** button to start cloning the TV configuration to the SmartLoader.

Cloning the SmartLoader configuration to the TV

- Slide button on the left of the Smart Loader up to the  position. Aim SmartLoader at green LED of the TV (5 to 15 cm away).



- Press the **MENU** button on the SmartLoader to display the menu on TV.

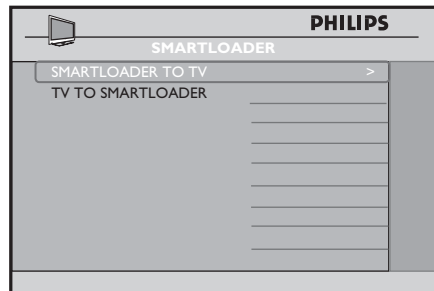

- Press the **∧** or **∨** button to select **SMARTLOADER TO TV**.
- Press the **>** button to start cloning the SmartLoader configuration to the TV.

Installing a System SmartCard or System Box

NOTE: Before installing a System SmartCard or System Box, ensure the TV is switched off.

1. Inserting the System SmartCard or System Box

- Insert the **SmartCard** into the SmartCard slot on the rear of the TV (available for certain models only) and connect the other cables as directed by the System provider.
- After the SmartCard has been inserted and the cables connected, switch on the TV.

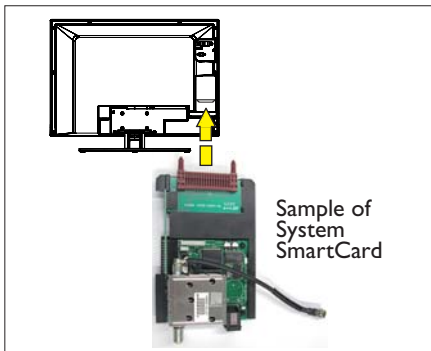

- For For the **System Box**, insert the RJ12 cable of the System Box to the DATA 11 (RJ12) connector on the rear of the TV and connect the other cables as directed by the System provider.
- After all the connection of cables are completed, switch on the TV.

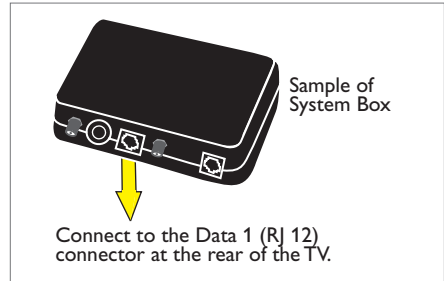

2. Setting up the correct Communication Source

Note: The default setting in the Communication menu is **OFF**. If a System SmartCard or System Box is used with this TV, the Communication menu item must be set to the correct communications protocol. For purposes of providing an example only, **SP - I2C** is selected as the communications protocol.

- In the **SETUP** menu, select **COMMUNICATION**.
- Press the > button to enter **COMMUNICATION** menu.
- Press the > button to select **SP - I2C**.

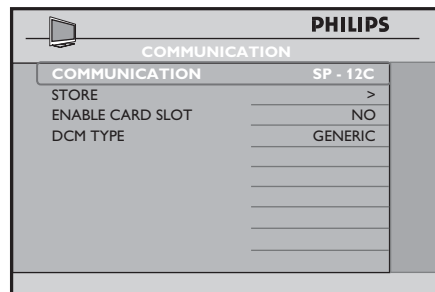

Installing a System SmartCard or System Box

3. Enabling the Card Slot

For the System SmartCard or System Box to function, the Card Slot must be enabled.

- Press the **V** button to select **ENABLE CARD SLOT**.

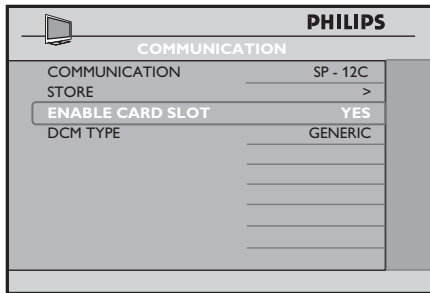

- Press the **>** button to select **YES** (if applicable).
- Press the **V** button to select **STORE** and press the **>** button to store selections.

4. Selecting the Low Power Standby

For the System SmartCard or System Box to function, **NO** must be selected.

- In the **CONFIGURATION** menu, select **FEATURES**.
- Press the **>** button to enter the **FEATURES** menu.
- Press **V** button and select **LOW POWER STANDBY**.

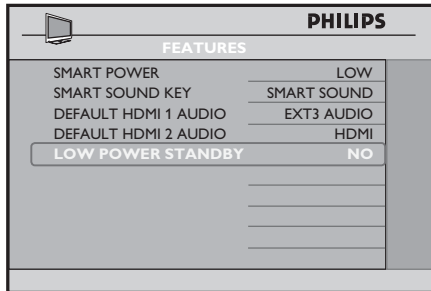

- Press the **>** button to select **NO**.

5. Checking the installation of System SmartCard or System Box

- To check whether the installation is done correctly, press the **RECALL** button on the green remote control to display menu.

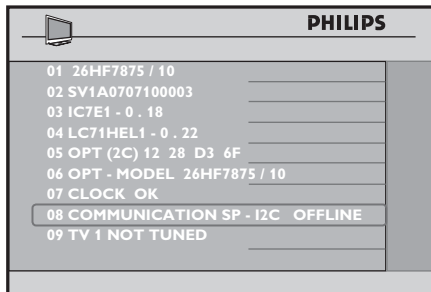

- See item 08 of the menu. If **SP - I2C** shows **"OFFLINE"**, check whether the System SmartCard is correctly inserted into the card slot of the TV.
- For System Box, check whether the **RJ12 cable** and connection between terminal and TV is properly connected.
- For more information, see "Diagnosing Basic Problems" on pages 38-39.

Diagnosing Basic Problems

1. TV does not seem to communicate with the external interactive terminal.

– Check the Communication Source

- Press the **RECALL** button on the remote (in Setup position). Item 08 of the menu should read **COMMUNICATION SP - I2C ONLINE**.

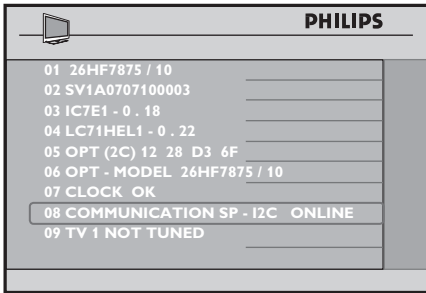

- If it is not **SP - I2C**, press the **MENU** button on the remote to display the Setup menu. Press the **V** button to select **COMMUNICATION**.

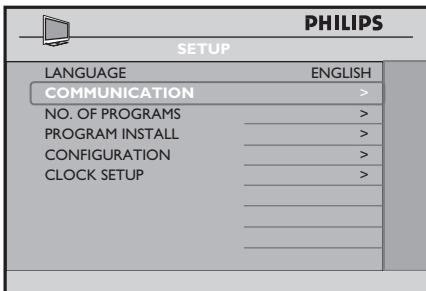

- Press the **>** button to enter **COMMUNICATION** menu.

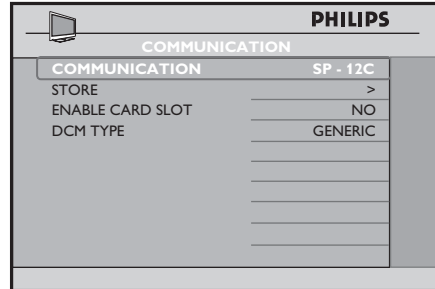

- Press the **>** button to select **SP - I2C**.

– Check the insertion and connection

- If the TV still does not communicate with the external interactive terminal after selecting the correct Communication source, press the **RECALL** button on the remote. Check item 08 of the menu.

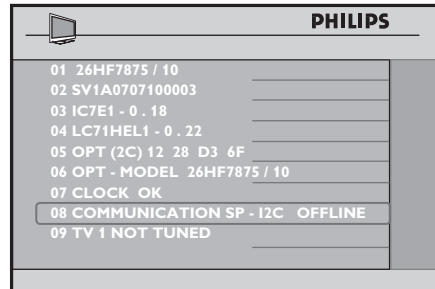

- If it reads "**COMMUNICATION SP - I2C OFFLINE**", check the RJ12 cable and connection between terminal and TV is properly connected for the System Box.
- For the System SmartCard, check the SmartCard is correctly inserted into the card slot of the TV.

Diagnosing Basic Problems

– **Check whether the Card Slot is enabled**

- If the TV still does not communicate with the System SmartCard, in the **COMMUNICATION** menu, press the **∨** button repeatedly until **ENABLE CARD SLOT** is highlighted.

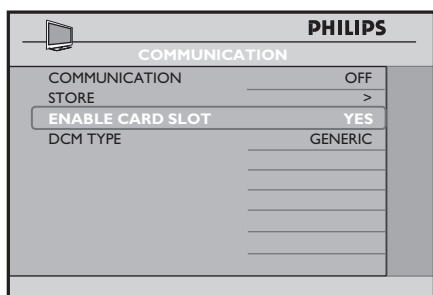

- Press the **>** button to select **YES** to enable System Card or System Box functions.
- Press the **∧** button to select **STORE** and press the **>** button to store all selections.

– **Check the Low Power Standby option**

- For the System SmartCard or System Box to function, **NO** must be selected.
- In the **CONFIGURATION** menu, select **FEATURES**.
- Press the **>** button to enter the **FEATURES** menu.

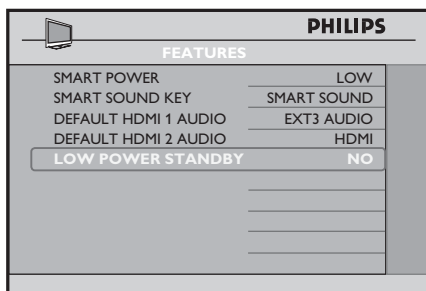

- Press **∨** button and select **LOW POWER STANDBY**.

2. An “F” appears in the upper hand corner of the TV screen.

This indicates that the TV is in factory mode.

- To restore to normal operation, press and hold the **PROGRAM DOWN** and **VOLUME DOWN** keyboard buttons on the side of the TV for a few seconds.

3. Picture performance not at optimum when using VGA or EXT 4 source

- To ensure optimal picture performance and no distortion when using this TV with a **VGA** or **EXT 4** source, avoid connecting a **VGA** input and a **EXT 4** input simultaneously to the TV.

Appendix A – Multi Remote Controls Support

Programming the Multi Remote Controls function

Multi RC function supports up to four TV sets operating in one room without any interference from each other remote controls. Each Guest Remote Control must be programmed individually to one of the four colour (Blue, Yellow, Green and Red) buttons on the remote control.

1. Press the **M** button on the **GREEN** remote control to activate the TV **SETUP** Menu.
2. Press the **V** button to select **COMMUNICATION**.

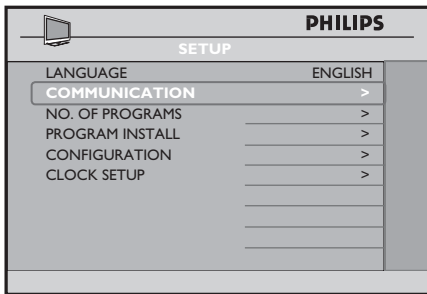

3. Press the **>** button to enter the **COMMUNICATION** menu.

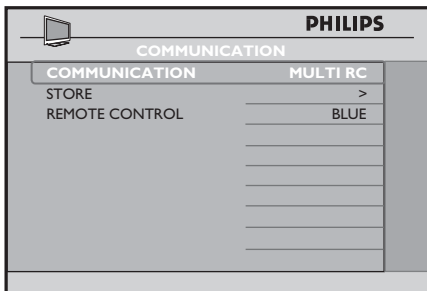

4. Press the **>** button repeatedly until **MULTI RC** is selected.
5. Press the **V** button to select **REMOTE CONTROL**.

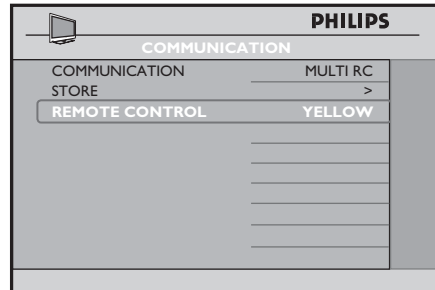

6. Press the **>** button repeatedly to toggle through the four colours and select your preferred colour.
7. Press the **^** button to select **STORE** and press the **>** button to store your selection. Press the **M** button to exit menu.
8. Using the Guest Remote Control, press the **MENU** and the **YELLOW** buttons simultaneously to set the remote control to the corresponding colour that you have selected in the **REMOTE CONTROL** option. If **BLUE** colour is selected at the **REMOTE CONTROL** option, correspondingly, you must select **BLUE** colour button on the Guest Remote Control.

You can now use the Guest Remote Control to operate the TV set.

9. To check whether you have programmed the **MULTI RC** function correctly, press the **OK** button on the Guest Remote Control for five seconds.

Information of the Remote Battery, Remote Colour and the TV Colour will be shown on the screen. If the Remote Colour and the TV Colour do not match, you need to re-programme and ensure they match to enable the Guest Remote Control to operate the TV.

Appendix B – Resolutions Table

Refer to the HDMI INPUT table if you use the HDMI connector to plug in a PC (PC Format) or a Video Input (Video Format), for example, a HDMI DVD player.

HDMI INPUT		
Mode	Signal Format	
PC Format	640 x 480	60 Hz, 72 Hz, 75 Hz, 85 Hz
	800 x 600	60 Hz, 72 Hz, 75 Hz, 85 Hz
	1024 x 768	60 Hz, 70 Hz, 75 Hz, 85 Hz
	1280 x 768	60 Hz
	1280 x 1024	60 Hz
	1360 x 768	60 Hz
Video Format	720 x 480p	60 Hz
	720 (1440) x 480i	60 Hz
	720 x 576p	50 Hz
	720 (1440) x 576i	50 Hz
	1280 x 720p	60 Hz
	1280 x 720p	50 Hz
	1920 x 1080i	50 Hz, 60 Hz
	1920 x 1080p	50 Hz, 60 Hz

Refer to the PC Analogue, D-sub input table if you connect the PC via VGA connector.

To ensure optimal picture performance and no distortion when using this TV with a VGA or EXT 4 (Y Pb Pr) source, avoid connecting a VGA input and a EXT 4 (Y Pb Pr) input simultaneously to the TV.

PC Analogue, D-sub input		
Mode	Signal Format	
PC Format	640 x 480	60 Hz, 72 Hz, 75 Hz, 85 Hz
	720 x 400	70 Hz
	800 x 600	60 Hz, 72 Hz, 75 Hz, 85 Hz
	1024 x 768	60 Hz, 70 Hz, 75 Hz, 85 Hz

Environmental Information



Recycling

The packaging of this product is intended to be recycled. Contact your local authorities for information about how to recycle the packaging.



Disposal of your old product

Your product is manufactured with high-quality materials and components which can be recycled and reused. When you see the crossed-out wheel bin symbol attached to a product, it means the product is covered by the European Directive 2002/96/EC.

Please familiarise yourself about your local systems for the disposal of electrical and electronic products. Please act according to your local regulations and do not dispose your old products with your normal household waste. The correct disposal of your old product will help to prevent potential negative consequences for the environment and for human health.

Disposal of batteries

The supplied batteries do not contain the heavy metals, mercury and cadmium. Please dispose off exhausted batteries according to your local regulations.

Power consumption

- This TV consumes minimal energy in standby mode to minimise environmental impact.
- Active power consumption is given on the type plate at the rear of the TV.

For more product specifications, see the product leaflet on www.philips.com/professional.

Note: Specifications and information are subject to change without notice.



For further assistance, call the customer support service in your country. The telephone numbers and addresses are given in the worldwide guarantee booklet supplied with the TV.

Electric, Magnetic and Electromagnetic Fields (EMF)

- Royal Philips manufactures and sells many products targeted at consumers, which, like any electronic apparatus, in general have the ability to emit and receive electromagnetic signals.
- One of Philips' leading Business Principles is to take all necessary health and safety measures for our products, to comply with all applicable legal requirements and to stay well within the EMF standards applicable at the time of producing the products.
- Philips is committed to develop, produce and market products that cause no adverse health effects.
- Philips confirms that if its products are handled properly for their intended use, they are safe to use according to scientific evidence available today.
- Philips plays an active role in the development of international EMF and safety standards, enabling Philips to anticipate further developments in standardization for early integration in its products.

Information for Users in the UK

(Not applicable outside UK)

Positioning the TV

For the best results, choose a position where light does not fall directly on the screen, and at some distance away from radiators or other sources of heat. Leave a space of at least 5 cm all around the TV for ventilation, making sure that curtains, cupboards etc. cannot obstruct the air flow through the ventilation apertures. The TV is intended for use in a domestic environment only and should never be operated or stored in excessively hot or humid atmospheres.

General Points

Please take note of the section entitled 'Tips' at the end of this booklet.

Interference

The Department of Trade and Industry operates a Radio Interference Investigation Service to help TV licence holders improve reception of BBC and IBA programmes where they are being spoilt by interference. If your dealer cannot help, ask at a main Post Office for the booklet "How to Improve Television and Radio Reception".

Mains connection

Before connecting the TV to the mains, check that the mains supply voltage corresponds to the voltage printed on the type plate on the rear panel of the TV. If the mains voltage is different, consult your dealer.

Important

This apparatus is fitted with an approved moulded 13 AMP plug. Should it become necessary to replace the mains fuse, this must be replaced with a fuse of the same value as indicated on the plug.

1. Remove fuse cover and fuse.
2. The replacement fuse must comply with BS 1362 and have the ASTA approval mark. If the fuse is lost, make contact with your retailer in order to verify the correct type.
3. Refit the fuse cover.

If for any reason the fitted plug is not suitable for your socket outlet, please consult your retailer or a qualified electrician before proceeding with the installation.

Connecting the aerial

The aerial should be connected to the socket marked  at the back of the set. An inferior aerial is likely to result in a poor, perhaps unstable picture with ghost images and lack of contrast. Make-shift loft or set-top aerials are often inadequate. Your dealer will know from experience the most suitable type for your locality. Should you wish to use the set in conjunction with other equipment, which connects to the aerial socket such as TV games, or a video camera it is recommended that these be connected via a combiner unit to avoid repeated connection and disconnection of the aerial plug.

Fitting the stand (if provided)

Use only the stand provided with the set, making sure that the fixings are properly tightened. A diagram showing how to assemble the stand is packed with the stand. Never use a make-shift stand, or legs fixed with woodscrews.



© 2007 Koninklijke Philips N.V.

All rights reserved

Document order number